

# INSTALLATION INSTRUCTIONS



1917 OAK PARK BLVD. • PLEASANT HILL, CA 94523  
(925)935-3025 • Fax (925)935-2287

## Throttle Stops Models

**TS-1** (Std. Holley)  
**TS-5** (Dom. Holley)  
also **TS-1A** (CO2 - Std. Holley)  
**TS-5A** (CO2 - Dom. Holley)

### INSTALLATION

- 1) Remove the carburetor, gasket, and mounting studs.
- 2) Install the four long mounting studs supplied with the Throttle Stop.
- 3) Install a new gasket, the Throttle Stop (solenoid forward), a 4-hole gasket and then the carburetor.
- 4) Wire the Throttle Stop as shown in the following drawings. In all cases the power to the Stop should come directly from the master cut-off switch at the back of the car.

**ELECTRIC SOLENOIDS** - If you are using electric solenoids, use one 10-amp circuit breaker and at least a 10 gauge wire to the solenoid's positive (+) terminal. Ground the negative (-) terminal to a carb stud.

**CO2 SYSTEMS** - If you are using CO2 actuator, a single 18 gauge supply wire will be sufficient. Use a 5 amp fuse in the power line.

If you are using a CO2 system, plumb the air line by taking the 1/4" diameter plastic tubing from your CO2 bottle regulator and push it into the orange air fitting on the needle valve. The tubing can be removed by pushing in on the orange locking ring and pulling on the tubing.

Recommended air line pressure from the CO2 bottle is 80-100 PSI. Minimum pressure for consistent operation is 75 PSI. Maximum pressure is 120 PSI. Use a CO2 system instead of compressed air because the compressed air systems foul up with oil and water condensation from the compressors used to fill up the bottle. They also do not maintain the consistent pressure needed for repeatable operation.

### INSTALLATION TIPS:

**ELECTRICAL SOLENOIDS** - The electrical solenoids do not draw power with the throttle stop in the closed position. When power is applied to open the stop, the solenoids draw 30 amps while the stop is snapping open. This is only an instantaneous pulse. When the stop is wide open, the solenoid internally switches to a "hold-in" coil and draw about 1 amp. If for any reason the butterflies do not fully open, the solenoid will overheat and burn themselves out. To prevent this, a 10 amp circuit breaker must be installed in the solenoid electrical supply wire. If using a Throttle Stop Controller, install the circuit breaker in the controller's +12v wire. The purpose of using large 10 gauge wire connected directly to the master cut-off switch at the back of the car is to prevent voltage drop to the solenoid. If the voltage is low at the solenoid, the stop may not open fully and it will quickly burn itself out (or "pop" the circuit breaker). Solenoids returned with burned out coils will not be covered under warranty.

**CO2 SYSTEMS** - The CO2 actuated throttle stops draw very little power, about .75 amps. Therefore they only need a 18 gauge power wire. If you are using a Throttle Stop Controller, you should install a 5-amp fuse in the controller's +12v wire. The needle valve determines how fast the Throttle Stop opens. For a starting point, loosen the locking ring on the needle valve and turn it all the way in. Then back out the needle valve 4 turns and tighten the locking ring. Backing the needle valve out further opens the Throttle Stop faster and turning it in opens it slower. In general, the quicker you can open the stop, the more consistent the car will be.

### SEE REVERSE SIDE FOR WIRING DIAGRAMS

Dedenbear Throttle Stop Controllers Models TSC-2A and TSC-4 have a "OUTPUT" switch located on the front of the box. This switch controls the polarity of the OUTPUT terminal. Early models had a small chrome toggle, while later models have two micro-rocker switches located under a 1/2-inch black plastic screw. For normal operation of Throttle Stops models TS-1 & TS-5, flip the toggle/rockers UP to the "ON-OFF-ON" output mode.

**Note:** If you are using a Model TSC-2A or Model TSC-4 Throttle Stop Controller, move the toggle switch or micro switches to the **UP** position. (On-Off-On sequence)

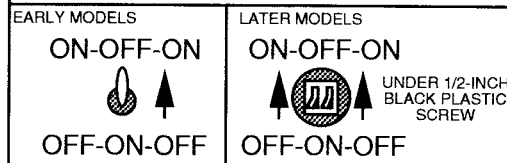

**WIRING & PLUMBING:** Use 10 gauge wire for Electric Solenoids & 18 gauge for CO2 systems.

**ELECTRIC**

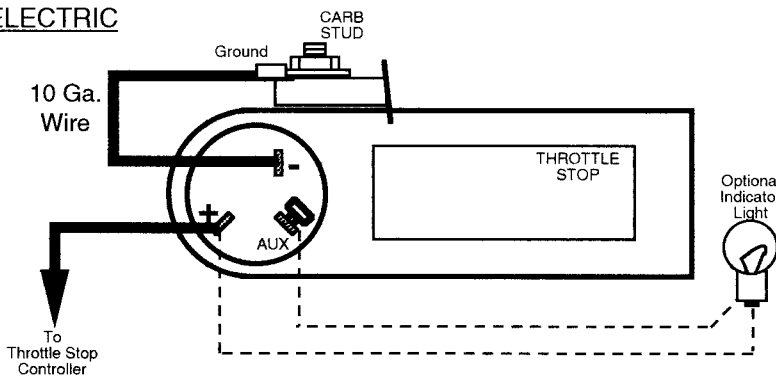

**CO2**

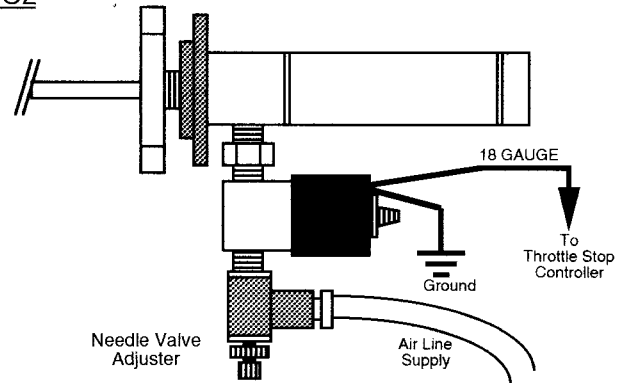

**HIGH GEAR SHIFT**

If Throttle Stop is to be controlled by the High Gear Shift, mount a 15-20amp rated pushbutton behind your shifter, so it is pressed when you are in LOW GEAR. Wire to the COM and N.O. terminals.

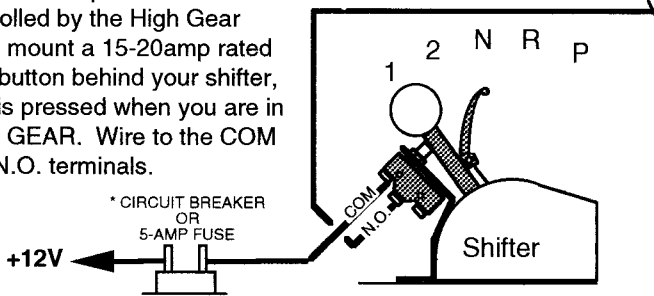

**CO2 actuator**

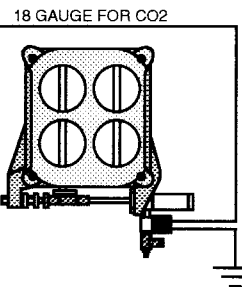

**Electric Solenoid**

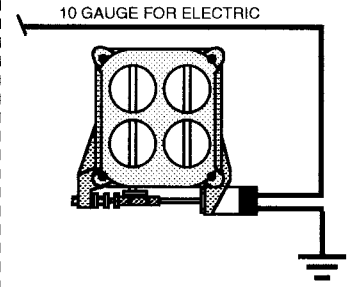

- Install a 10-amp circuit breaker for ELECTRIC systems.
- Install a 5-amp fuse for CO2 systems.

**SINGLE CONTROLLER**

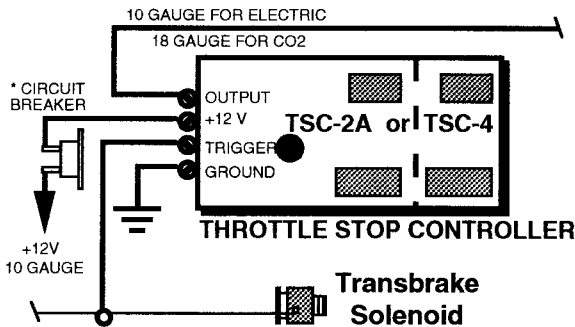

**CO2 actuator**

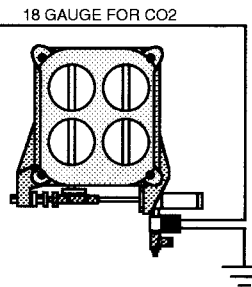

**Electric Solenoid**

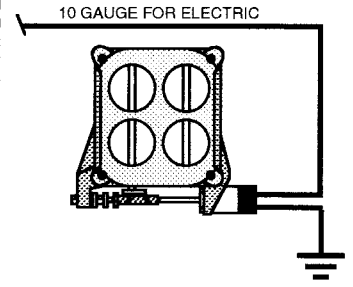

- Install a 10-amp circuit breaker for ELECTRIC systems.
- Install a 5-amp fuse for CO2 systems.

**LIMITED 1 YEAR WARRANTY**

Dedenbear Products components are warranted directly by Dedenbear Products against defective materials or workmanship under normal use and service for a period of one (1) year after purchase. Dedenbear Products will repair or replace the defective unit, at Dedenbear Products option, free of charge. This warranty does not cover any damage to the component caused by abuse, mishandling, alteration, accident, electrical current fluctuations, failure to follow installation/operating instructions, maintenance, storage and environmental conditions, acts of God, or repair attempts made by anyone other than Dedenbear Products Authorized Service facility.

DEDENBEAR PRODUCTS SHALL NOT BE LIABLE FOR INJURY, CONSEQUENTIAL, OR OTHER TYPE DAMAGES RESULTING FROM THE USE OF ITS PRODUCTS, OTHER THAN THE LIABILITY STATED ABOVE. This warranty is in lieu of all other warranties of merchantability or fitness of use. This warranty gives you specific legal rights, and you may also have other rights which vary from state to state.

**FOR SERVICE** on all Dedenbear Products, return directly to: **DEDENBEAR PRODUCTS, INC. • ATTN: REPAIRS • 1917 OAK PARK BLVD. • PLEASANT HILL, CA 94523.** For **Faster Service**, please include a note describing the nature of the problem, a copy of your original invoice, your name, return shipping address, and daytime & evening phone numbers where you can be reached. Or call us and we'll take down the information. Normal turn-around time on service is typically 24-48 hours.

**CUSTOMER SERVICE & TECH. SUPPORT : (925)935-3025 Mon-Fri 8am-5pm PST**